

Data Sheet



Article number: 02150000112

Description: Sealing Clamp S 112 W1

Measures

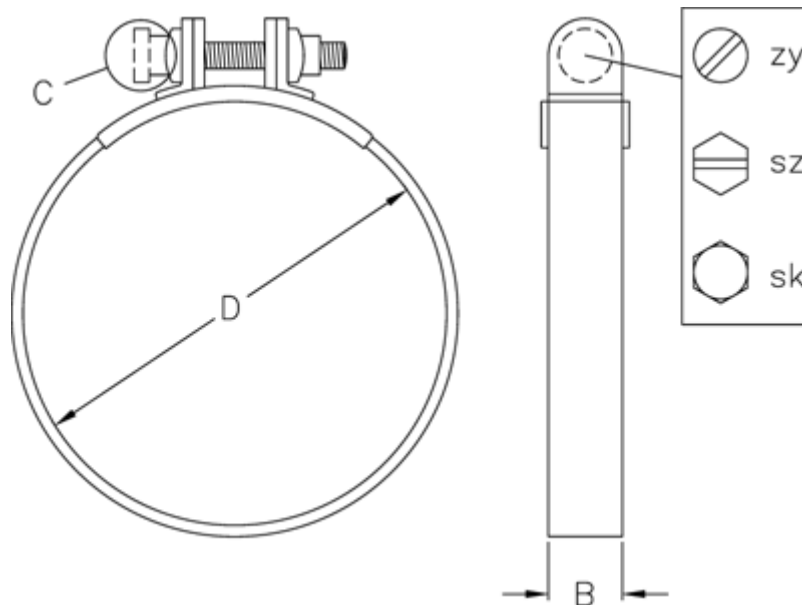

C (screw type)	= SZ
Diameter D	= 112
Width B	= 20